

# TEDDICO

## ELECTRICAL PRODUCTS



### 4" STEEL POLE SPEC SHEET

Pre-drilled for side mount arms, polycarbonate plugs included.  
 Reinforced cast iron hand-hole cover with ground screw.  
 Easily secured base cover.  
 Set of four (4) anchor bolts (J-bolts) included.  
 Conforms to ASTM-A 500 Grade B: minimum yield strength of 46,000 PSI  
 Polyester powdercoat finish to ensure maximum paint adhesion. Baked to  
 Ensure maximum hardness and durability.  
 Wall thickness available in 11 gauge (.120") or 7 gauge (.180")  
 Base Plate Size: 10.5" x 10.5" x 3/4"  
 Anchor bolt size: For the 16' and 20' 11 gauge poles, 3/4" x 30"  
 For the 25' 11 gauge and the 20' and 25' 7 gauge poles, 1" x 36"  
 Color: Bronze (Additional colors available upon request)

11 GAUGE - Wind Specification: 80 MPH-			11 GAUGE - Wind Specification: 90 MPH -			11 GAUGE - Wind Specification: 100 MPH -		
Height	Max EPA	Max Fixture Wt	Height	Max EPA	Max Fixture Wt	Height	Max EPA	Max Fixture Wt
16 ft	15.8	399 lbs	16 ft	12.3	348 lbs	16 ft	9.6	312 lbs
20 ft	10.1	320 lbs	20 ft	7.6	279 lbs	20 ft	5.7	275 lbs

7 GAUGE - Wind Specification: 80 MPH-			7 GAUGE - Wind Specification: 90 MPH -			7 GAUGE - Wind Specification: 100 MPH -		
Height	Max EPA	Max Fixture Wt	Height	Max EPA	Max Fixture Wt	Height	Max EPA	Max Fixture Wt
20 ft	16.8	433 lbs	20 ft	13.2	380 lbs	20 ft	10.2	345 lbs
25 ft	10.7	360 lbs	25 ft	7.4	319 lbs	25 ft	5.2	293 lbs

## ORDERING INFORMATION

Catalog Number	Height	Gauge	Weight
<b>PSS41611</b>	<b>16'</b>	<b>11</b>	<b>126 lbs</b>
<b>PSS42011</b>	<b>20'</b>	<b>11</b>	<b>146 lbs</b>
<b>PSS4207</b>	<b>20'</b>	<b>7</b>	<b>209 lbs</b>
<b>PSS4257</b>	<b>25'</b>	<b>7</b>	<b>256 lbs</b>

## STEEL POLES



## Lighting Poles

### 4" x 4" Square Straight Steel Pole Accessories Dimensions

Catalog #	Description
PRSWMBZ	Wall Mount Bracket, Bronze Finish
PRSWMB90Z	Wall Mount 90° Bracket, Bronze Finish
PRSD180BHZ	180° Double Round Bullhorn Tenon, Slips 2 3/8" Tenon, Bronze Finish
PRSTR180BHZ	180° Triple Round Bullhorn Tenon, Slips 2 3/8" Tenon, Bronze Finish
PRSQ180BHZ	180° Quad Round Bullhorn Tenon, Slips 2 3/8" Tenon, Bronze Finish
PSS4T90HTZ	4" 90° Twin Square Horizontal Tenon, Bronze Finish
PSS4T180HTZ	4" 180° Twin Square Horizontal Tenon, Bronze Finish
PSS4TR90HTZ	4" 90° Triple Square Horizontal Tenon, Bronze Finish
PSS4Q90HTZ	4" 90° Quad Square Horizontal Tenon, Bronze Finish
PSS4SVTZ	4" Single Square Vertical Tenon, Bronze Finish
PAB34X30	3/4" x 30" Anchor Bolts, Set of 4
PAB1X36	1" x 36" Anchor Bolts, Set of 4
PSSCVRZ	Base Cover
PSS4CZ	4" Polycarbonate Pole Cap

- **Conforms to ASTM-A 500 Grade B: Minimum Yield Strength of 46,000 PSI**
- **Bronze Polyester Powdercoat Finish to Ensure Maximum Paint Adhesion. Baked to Ensure Maximum Hardness & Durability**
- **All Stainless Steel Hardware Included**
- **Packed in Individual Cartons for Safe Shipping**



PRSWMBZ



PRSWMB90Z



PRSD180BHZ



PRSTR180BHZ



PRSQ180BHZ



PSS4T90HTZ



PSS4T180HTZ



PSS4TR90HTZ



PSS4Q90HTZ



PSS4SVTZ

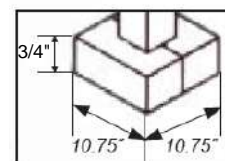

PSSCVRZ



PSS4CZ



## Lighting Poles

### 4" x 4" Square Straight Steel Pole Accessories Dimensions

- **PRSWMBZ** - Wall Mount Bracket
- **PRSWMB90Z** - Wall Mount 90° Bracket
- **PSS4SVTZ** - 4" Single Square Vertical Tenon
- **PSS4T90HTZ** - 4" 90° Twin Square Horizontal Tenon
- **PSS4T180HTZ** - 4" 180° Twin Square Horizontal Tenon
- **PSS4TR90HTZ** - 4" 90° Triple Square Horizontal Tenon
- **PSS4Q90HTZ** - 4" 90° Quad Square Horizontal Tenon

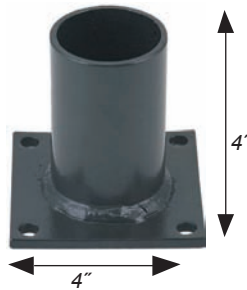

**PRSWMBZ**

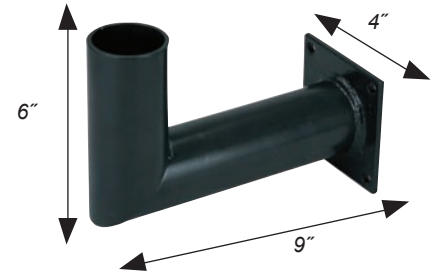

**PRSWMB90Z**

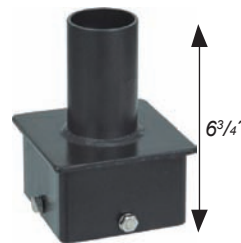

**PSS4SVTZ**

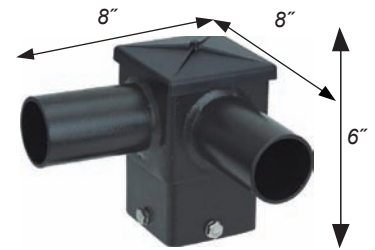

**PSS4T90HTZ**

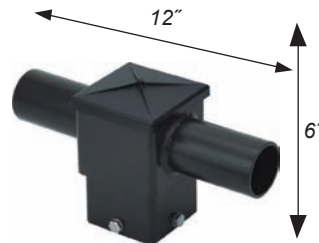

**PSS4T180HTZ**

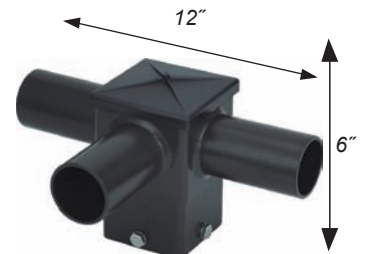

**PSS4TR90HTZ**

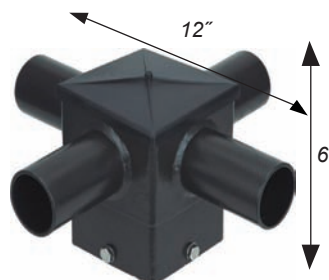

**PSS4Q90HTZ**

## Lighting Poles

### 4" x 4" Square Straight Steel Pole Bullhorn Dimensions

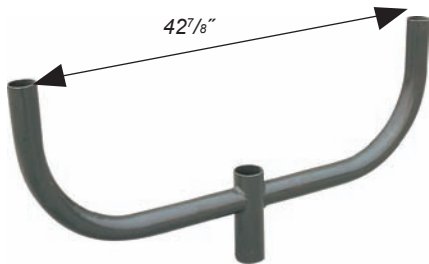

**PRSD180BHZ**

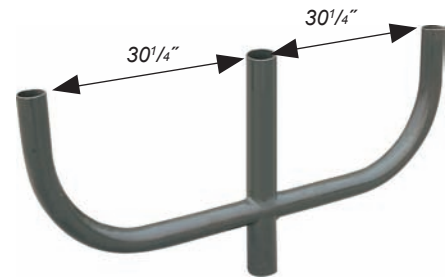

**PRSTR180BHZ**

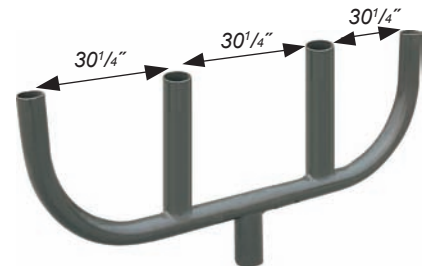

**PRSQ180BHZ**

- **PRSD180BHZ** - 180° Double Round Bullhorn Tenon, Slips  $2\frac{3}{8}$ " Tenon
- **PRSTR180BHZ** - 180° Triple Round Bullhorn Tenon, Slips  $2\frac{3}{8}$ " Tenon
- **PRSQ180BHZ** - 180° Quad Round Bullhorn Tenon, Slips  $2\frac{3}{8}$ " Tenon

# TEDDICO

## ELECTRICAL PRODUCTS



### Lighting Poles

#### Bullhorns



**BHRD180**

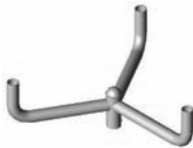

**BHRT120**



**BHRT180**

- Rugged Steel Construction
- Bronze Powdercoat Finish
- Available in Dual or Triple Models
- Triple Bullhorns Available in 120° or 180° Models
- Includes Top Caps
- Tenon O.D. 2 3/8"
- Bullhorn I.D. 2 1/2"
- Decorative Center Cap Included

Custom Colors Available Upon Request.

Complete Units					
Catalog #	Width	Height	Depth	Tenons	Degrees
BHRD180	32"	13"	-	Dual	180
BHRT120	37"	13"	37"	Triple	120
BHRT180	61"	13"	-	Triple	180

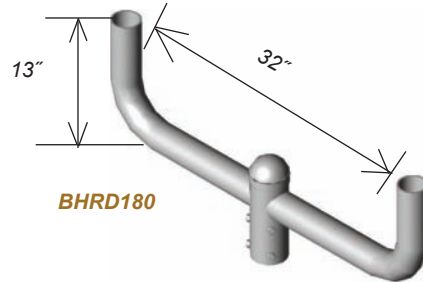

**BHRD180**

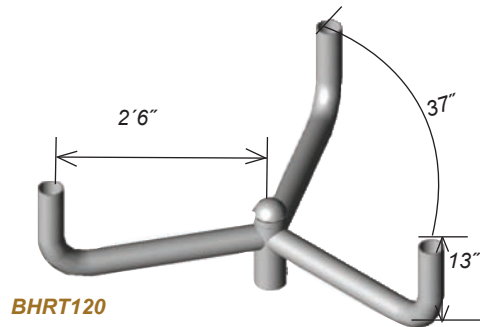

**BHRT120**

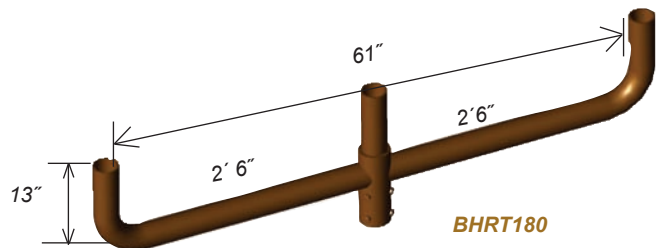

**BHRT180**